



EUCOMM/KOMP-CSD 'Knockout-First' Genotyping

Introduction

The majority of animals produced from the EUCOMM/KOMP-CSD ES cell resource contain the Knockout-First-Reporter Tagged Insertion allele. As well as gene specific elements, the targeting cassette contains many common elements e.g. encoding beta-galactosidase (lacZ gene), neomycin-resistance (neo gene), FRT and loxP sites. Further details can be found on <http://www.knockoutmouse.org/about/eucomm>. The majority of cassettes will be either promoter driven where the neo gene contains its own promoter and is separated from the lacZ gene by a 3rd loxP site, or promoterless (PL) where the neo and lacZ genes are adjacent and there are only 2 loxP sites. These have further implications in our genotyping strategies detailed later.

Promotor driven line



Promotorless line



Animals containing the full Knockout-First mutant allele (Tm1a) above can be crossed to mice expressing Flp or Cre recombinase. The progeny from these mating may contain converted forms of the Tm1a allele known as Tm1b, Tm1c and Tm1d depending on the breeding strategy performed. In order to genotype animals generated from the EUCOMM/KOMP-CSD 'Knockout-First' ES cell resource, a combination of mutant assays looking for sequences occurring in the targeting cassette, and WT specific assays will need to be performed. We typically use real time qPCR and copy count the various alleles. This assay design sheet will give an outline of how to genotype these lines by gel based and qPCR based technologies, as well as including details of assays we have tried and tested.



Fam151b-Tm1a

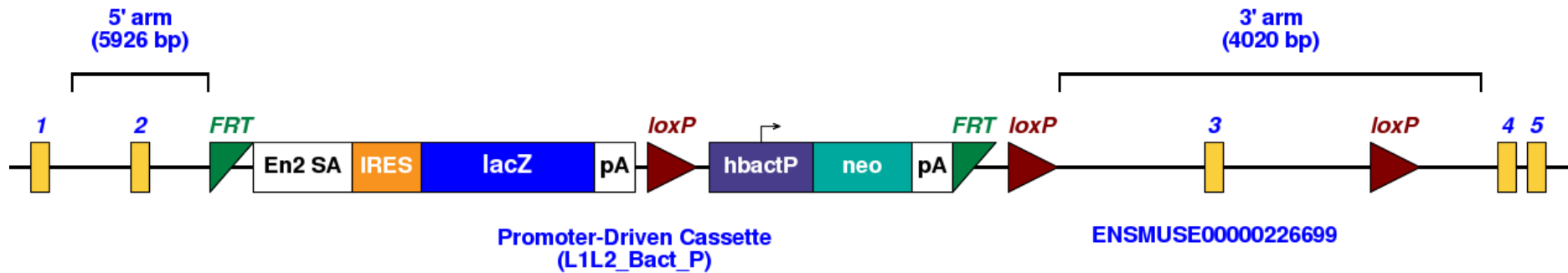

Details for the tm1a allele can be found below

http://www.mousephenotype.org/martsearch_ikmc_project/martsearch/ikmc_project/45257



Types of alleles

Promotor driven lines

WT allele



Tm1a promotor driven construct



Tm1b created by action of Cre recombinase on Tm1a allele



Tm1c created by action of Flp recombinase on Tm1a allele

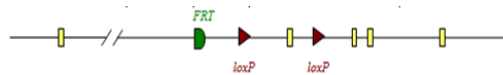

Tm1d created by action of Cre recombinase on Tm1c allele

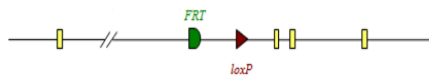

Promotorless lines

WT allele



PL-Tm1a (promotorless) construct

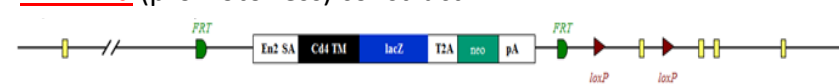

PL-Tm1b created by action of Cre recombinase on PL-Tm1a allele



Tm1c created by action of Flp recombinase on PL-Tm1a allele

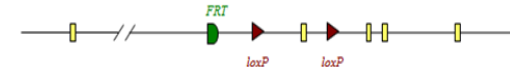

Tm1d created by action of Cre recombinase on Tm1c allele

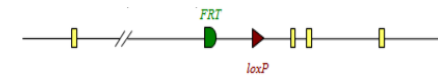



Gel based genotyping

The gel based assays are normally run on the Qiagen QIAxcel. This is a capillary based system that provides clearer resolution and is quicker than running standard agarose gels. Different size ladders may be loaded onto runs depending on the fragment sizes being analysed. Typically samples are run with a 50-800bp size ladder.

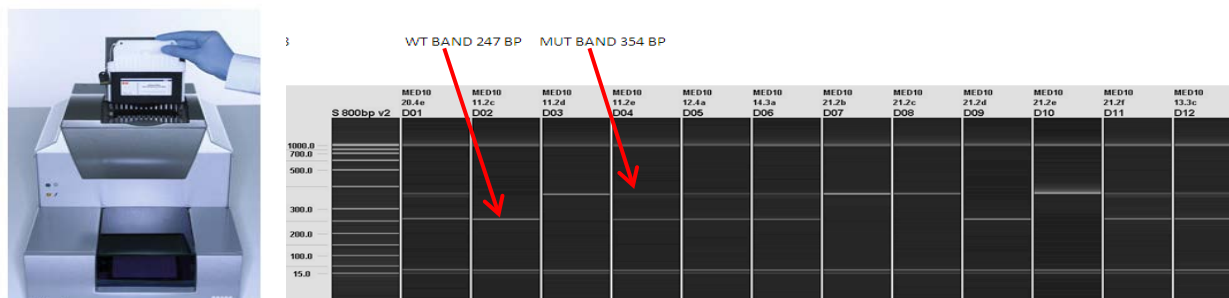

PCR is performed using KAPA fast Taq polymerase, although alternatives may be used.

Generic 4 primer PCR mix

KAPA Taq PCR master mix	5µl
Primer 1F	0.5µl
Primer 1R	0.5µl
Primer 2F	0.5µl
Primer 2R	0.5µl
H ₂ O	2.0µl
DNA	1µl

60°C Cycling conditions

60TM30FA		
1.	95°C	1min
2.	95°C	10sec
3.	60°C	10sec
4.	72°C	1sec
5.	Go to 2 for 29 cycles	
6.	72°C	30sec
7.	16 °C	forever



Types of gel based assay

The diagram below shows the location of the various gel based primers.

Promotor Driven TM1A

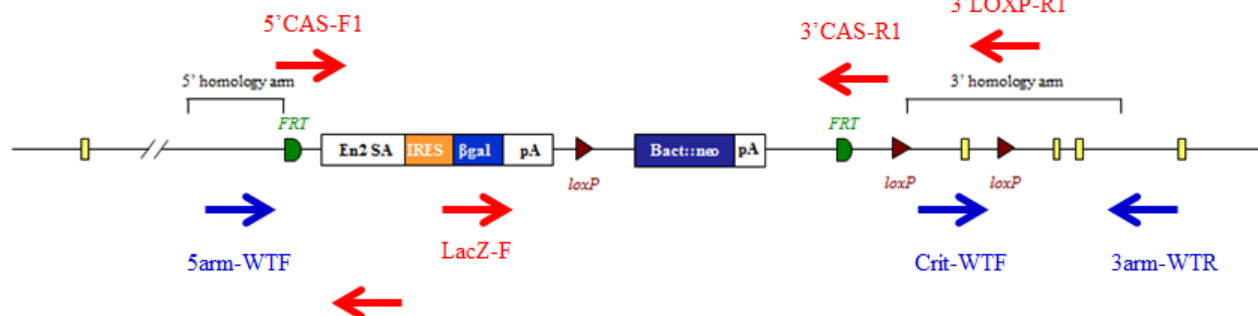

Promotorless TM1A

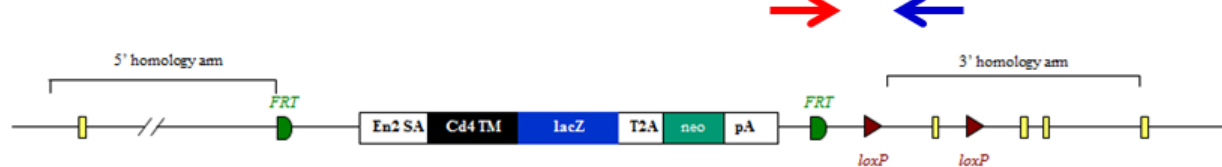

Mutant primer sequences

5mut-R1	GAACTTCGGAATAGGAACTTCG
LacZ-F	CCAGTTGGTCTGGTGCA
SV40-FRT-F	CGCGTCGAGAAGTTCCTATT
5'CAS-F1	AAGGCGCATAACGATACCAC
3'CAS-R1	CCGCCTACTGCGACTATAGAGA
3'LOXP-R1	ACTGATGGCGAGCTCAGACC



Tm1a gel based genotyping

Tm1a gel based assays are designed using a universal mutant reverse primer that sits in the sequence just after the 5' homology arm

5mut-R1 GAACTTCGGAATAGGAACTTCG

A forward primer is designed to the 5' homology arm and designed to give a mutant specific band, typically between 100-150bp that will only be present if the cassette is present.

A WT reverse primer is designed to the critical region and should give a product of >200bp. If the mutant cassette is present the product between the two primers is too large to PCR under standard conditions.

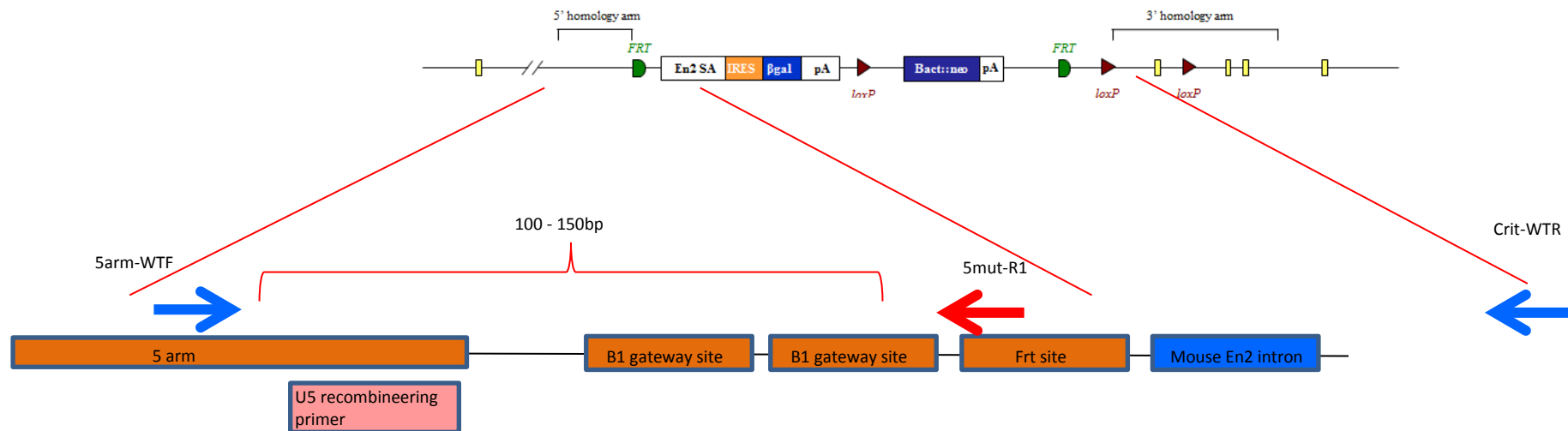



Fam151b Tm1a gel based genotyping

Fam151b 'Knockout'-First and WT sequences

5'homology arm (last 300bp)

```
CTGAGCCATCTCTCTAGCCCCAGCTTGTGGGTTTATTACCTACCAAATTATAAACTACTCCTTTAGCCAAAAGCCAGAAACCTAGATTACTTTTGTGATGGTCTTCACTCTGGGCTG
GATGGTCTACAGGTTTGGTTACTGTGAACCTACACTTAGTAGTCTAAATTCTCTTACATAGTTATGTGGGAGCAGCCATCTCTCTGAGGTTTTTCATAAAGAGTCTTGCAGTTGC
CCTGTTGGCACGGAAATTATATTTTATTGTACTTTTTATTTGAAAGTTTGTCTTCTCCAAACTCGAAGG
```

Mutant 5'sequence location of 5mut-R1 (mutant reverse primer)

```
AAGGCGCATAACGATACCACGATATCAACAAGTTTGTACAAAAAAGCAGGCTGGCGCCGGAACCGAAGTTCCTATTCCGAAGTTCCTATTCTCTAGAAAGTATAGGAACTTCGAAC
CCTTTCCACACCACCCTCCACACTTGCCCCAAACACTGCCAAC
```

Critical region

```
TTTCCTTAGTATGCTATTA AAAAGTCCCAACAGCGAATTGTTACCTTTCTCGAACAAATCCTTATCACAATTGACGCTTTGAGCATCTCCTCGAAACCACCTGTGTCAGCTCATA
GTACTTACTAGGCAAGTAGCACCTTTGAGGGACACTCTGTGTCCAAATATACTATTTTTATTACCAACAAATGCTTAATAGACTTCCCTTCTTTCTGTGTTCACTTTGCTAGATG
CTAGAAAAGATTTGTAGGCAGGATAATGGCTGAGGAGCTTTGGGATCTATGGATAGCATGCGGGCCCTCGTACAGTGCCCTGACATTC TAGAGTTGCTCGGTGTCCTTTCTTTCTCAC
ATGGGCACCGAGGCGCTTCTCCTCGATTTTCGTCTTGTTCACAGTAACGTAAGCTCTCTTACTTGGGTAGGTGCTGCCACATGATAGAGGCTGATGTCCTTCTTCTTAGTGACG
GATCAGAGCATGGCCAGCCAATCATGGCCCATCCTCTGAGACAAGCAGTGATAACACTTTGCAGGAGTGGCTGGCTGAGGTTGTGAAGAGCAACAAGGGCATCAAGTTGGATTTTC
AAGAGGTACTTTTACAAACGTGCTTTCGTGTTGCTGCAGAATTCGGGGAGAACAATTA AAACATGTGTCTCTGTCTGTGACGACTGTCTGTAGTTAGGGTTTTATTGTTGTAAAGCGTC
AGCATGACCACACCAACTCTTATCAAGGAAAACATTTAGTTGGAGCTGGCTTATAGTTTCAGAGGTTTAGTCTATTACCATCATGGCAAGAAGCATGGTGGCGTGCGGGCAGAAA
```

3'homology arm (1st 300bp)

```
ATTTCAAAGACCCTTGAACATAGGAGGTCTCAAACCCATCCCTATGGTGACATACTTCTCCAACAAGGCCACAGTCACACTAACAAGGCCATACCTCCTAATGGTGCCACTCCC
CATGGGCCAAGCATTACACACGAGTCTGTAGGGAATGAGCGTACCTATTTCAACCACAACACTTATTATACCTTTTTCTAAGCTGAAATGAAAATTTAGACCTCTGTGTGTTTCT
AGAATAGACTTAAAACAACAGCATGCTAATGGCTAAGATTGCTCCTTGAGGACTTTTAAGATTAAGT
```



Fam151b Tm1a gel based genotyping

Fam151b 'Knockout'-First and WT sequences

Genomic sequence

Black sequence is missing in the construct due to the insertion of loxP sites and can be used to design break point (BP) qPCR assays

```
CTGAGCCATCTCTCTAGCCCCAGCTTGTGGGTTTATTACCTACCAAATTATAAACTACTCCTTTAGCCAAAAGCCAGAAACCTAGATTACTTTGTGATGGTCTTCACTCTGGGCTG
GATGGTCTACAGGTTTGGTTACTGTGAACCTACACTTAGTAGTCTAAATTCCTTCCACATAGTTATGTGGGAGCAGCCATCTCTCTGAGGTTTTTTCATAAAGAGTCTTGCAGTTGC
CCTGTTGGCACGGAAATTATATTTTATTGTACTTTTATTTGAAGTTTGTCTTCTCCAACTCGAAGGTGAGGTCTCTAGGGAGGTTTGGGGTCTAAATTTGGAAACATTTCCTTA
GTATGCTATTAAAAAAGTCCCAACAGCGAATTGTTACCTTTCTCGAACAATCCTTATCACAATTGACGCTTTGAGCATCTCCTCGAAACCACCTGTGTCAGCTCATAGTACTTAC
TAGGCAAGTAGCACCTTTGAGGGACACTCTGTGTCCAAATATACTATTTTTATTACCAACAAATGCTTAATAGACTTCCCTTCCCTTCTGTGTTCACTTTGCTAGATGCTAGAAAA
GATTTGTAGGCAGGATAATGGCTGAGGAGCTTTGGGATCTATGGATAGCATGCGGGCCTCGTACAGTGCCTGACATTCTAGAGTTGCTCGGTGTCCTTCTTTCTCACATGGGCAC
CGAGGCGCTTCTCCTCGATTTTCTGTCCTTGTTCACAGTAACGTAAGCTCTCTTACTTGGGTAGGTGCTGCCACATGATAGAGGCTGATGTCTTCTTCTTAGTGACGGATCAGAG
CATGGCCAGCCAATCATGGCCATCTCCTGAGACAAGCAGTGATAACACTTTGCAGGAGTGGCTGGCTGAGGTTGTGAAGAGCAACAAGGGCATCAAGTTGGATTTCAAGAGGTA
CTTTTACAAACGTGCTTCGTGTTGCTGCAGAATTCGGGGGAGAACATTAACATGTGTCTCTGTCTGTGACGACTGTGCTAGTTAGGGTTTTATTTGTTGTAAAGCGTCAGCATGAC
CACACCAACTCTTATCAAGGAAAACATTTAGTTGGAGCTGGCTTATAGTTTTCAGAGGTTTAGTCTATTACCATCATGGCAAGAAGCATGGTGGCGTGCGGGCAGAAATGGTGTCTGG
AGGAGCTGAGAGTTCAACATCTTGATCCACAGGCAGCAAAGGAGACTGTGCCACACTGAGCATAGCTTAAGCATAGGAGATTTCAAAGACCCTTGAACATAGGAGGTCTCAAAC
CCATCCCTATGGTGACATACTTCCCTCCAACAAGGCCACAGTCACACTAACAAGGCCATACCTCCTAATGGTGCCACTCCCCATGGGCCAAGCATTACACACGAGTCTGTAGGGAA
TGAGCGTACCTATTTCAACCACAACTACTTATTATACCTTTTCTAAGCTGAAATGAAAATTTAGACCTCTGTGTGTTTCTAGAATAGACTTAAACAACAGCATGCTAATGGCTAA
GATTGCTCCTTGAGGACTTTTAAAGATTAAGT
```

5' homology arm and cassette sequence

```
CTGAGCCATCTCTCTAGCCCCAGCTTGTGGGTTTATTACCTACCAAATTATAAACTACTCCTTTAGCCAAAAGCCAGAAACCTAGATTACTTTGTGATGGTCTTCACTCTGGGCTG
GATGGTCTACAGGTTTGGTTACTGTGAACCTACACTTAGTAGTCTAAATTCCTTCCACATAGTTATGTGGGAGCAGCCATCTCTCTGAGGTTTTTTCATAAAGAGTCTTGCAGTTGC
CCTGTTGGCACGGAAATTATATTTTATTGTACTTTTATTTGAAGTTTGTCTTCTCCAACTCGAAGGAAGGCGCATAACGATACCAGATATCAACAAGTTTGTACAAAAAGCA
GGCTGGCGCCGGAACCGAAGTTCCTATTCCGAAGTTCCTATTCTCTAGAAAGTATAGGAACTTCGAACCCCTTTCCACACCACCCTCCACACTTGCCCCAAACACTGCCAAC
```



Tm1a gel based genotyping

Fam151b tm1a gel based primers

Fam151b_-5arm-WTF	AAGTTTGTCTTCTCCAAACTCG
Fam151B-Crit-WTR	GAGTGTCCCTCAAAGGTGCT
5mut-R1	GAACTTCGGAATAGGAACTTCG

WT band **219**
Mutant band **111**

PCR mix

KAPA Taq PCR master mix	5µl
5arm-WTF	0.5µl
Crit-WTR	0.5µl
5mut-R1	0.5µl
H ₂ O	2.5µl
DNA	1µl

Example of a generic TM1A assay

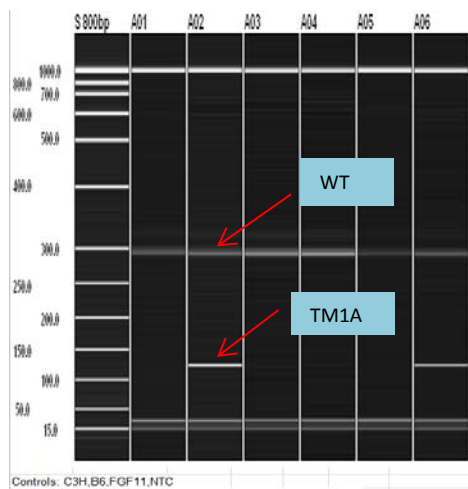

Cycling conditions

60TM30FA

1. 95°C 1min.
2. 95°C 10sec.
3. **60°C** 10sec.
4. 72°C 1sec.
5. Go to 2 for 29 cycles
6. 72°C 30sec.
7. 16 °C for ever
8. end



Tm1b gel based genotyping

Promotor driven genotyping

Tm1b alleles are produced by exposing tm1a alleles to cre recombinase which causes the deletion of Neo and the critical region.



If the deletion of the critical region has not occurred then a product is produced between the -Crit-WTF and the -3arm-WTR. Complete conversion by Cre will mean a product is produced from the LacZ-F and -3arm-WTR as the two primers now lie close enough to generate a PCR product under standard conditions. Run both the tm1a genotyping protocol to detect WT and tm1a alleles and the tm1b protocol to detect converted alleles.

Promotorless genotyping

PL-Tm1b (promotorless tm1b) mice are produced in a similar fashion but only the deletion of the critical region occurs and Neo is still present.



If the deletion of the critical region has not occurred then a product is produced between the Crit-WTF and the 3arm-WTR. Complete conversion by Cre will mean a product is produced from the SV40-FRT-F and 3arm-WTR as the two primers now lie close enough to generate a PCR product under standard conditions. This will not work for promotor driven lines as the presence of the 5' loxP site between the Neo and lacZ sequence causes this region to be removed by cre deletion. Run both the tm1a genotyping protocol to detect WT and tm1a alleles and the tm1b protocol to detect converted alleles.



Tm1c and Tm1d gel based genotyping

Tm1c genotyping

Tm1c alleles are produced by exposing tm1a alleles to flp recombinase which causes the deletion of Neo and LacZ sequences that are between the FRT sites.

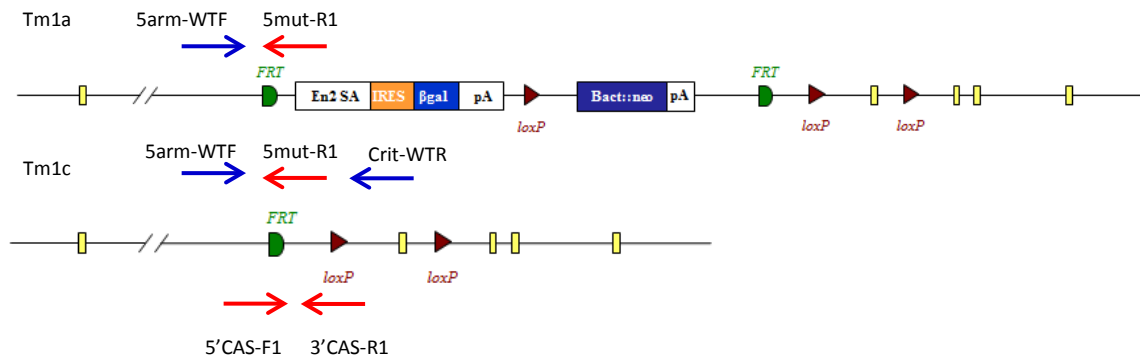

The protocol for tm1a genotyping needs to be run. Both tm1a and tm1c alleles will produce a mutant specific product from -5arm-WTF and 5mut-R1. WT and tm1c alleles will produce PCR products from -5arm-WTF and Crit-WTR although the tm1c product will be around 200bp bigger due to the presence of the FRT-loxP part of the cassette. In addition to this a generic tm1c assay can be used. This uses the 5'CAS-F1 and 3'CAS-R1 primers run with an internal control. The tm1c allele produces a 218bp product.

Tm1d genotyping

Tm1d mice are produced by crossing tm1c animals with mice expressing cre recombinase. This causes the deletion of the critical region.



The tm1d allele produces a 174bp product from the 5'CAS-F1 and 3'LOXP-R1 primers. A tm1c allele will produce a larger product which includes the critical region sequence. If the critical region is very large then a gene specific primer lying in the critical region may be needed to detect it (Crit-WTR).



Gel based genotyping strategy summary

	Primers to use										Comments
	5'CAS-F1	5mut-R1	LacZ-F	SV40-FRT-F	3'CAS-R1	3'LOXP-R1	5arm-WTF	Crit-WTF	Crit-WTR	3arm-WTR	
Tm1a + PL		√					√		√		
Tm1b			√					√		√	Run tm1a protocol to identify WT alleles
PL-Tm1b				√				√		√	Run tm1a protocol to identify WT alleles
Tm1c	√	√			√		√		√		Blue =separate reaction
Tm1d	√					√			√		Run tm1a protocol to identify WT alleles

- WT Product between 5arm-WTF and Crit-WTR (product too big in tm1a).
- Tm1a Product between 5arm-WTF and 5mut-R1.
- Tm1b Product between LacZ-F and 3arm-WTR (product too big in tm1a but PCR product from Crit-WTF and 3arm-WTR is made).
- Tm1b-PL Product between SV40-FRT-F and 3arm-WTR (product too big in tm1a but PCR product from Crit-WTF and 3arm-WTR is made).
- Tm1c 218bp product between 5'CAS-F1 and 3'CAS-R1 made. Can also run tm1a protocol for a gene specific assay.
- Tm1d 174bp product produced from 5'CAS-F1 and 3'LOXP-R1. Larger product may be produced by tm1c.



qPCR based genotyping

Standard PCR is the amplification of DNA between a pair of primers. Quantitative PCR employs the same principal as standard PCR, although it actually monitors the progress of the DNA synthesis as it occurs. The progress of the reaction is measured by using a Taqman probe. This is a short DNA oligo that is complimentary to part of the DNA sequence between the forward and reverse primers. At the 5' end of the probe there is a fluorescent reporter (R) and at the 3' end a quencher (Q). Whilst they are in close contact with each other there is no fluorescent signal.

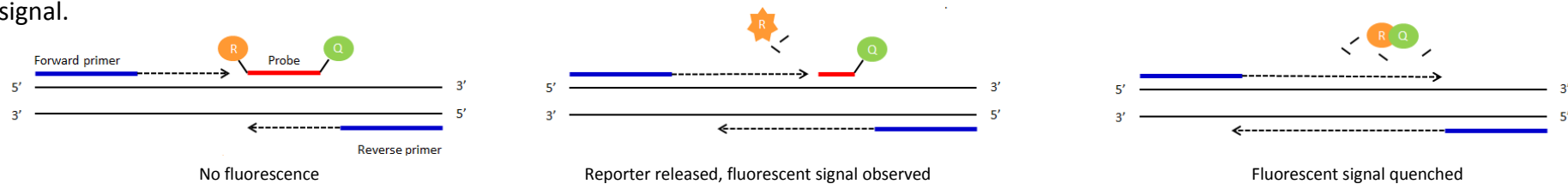

As the forward primer is extended the reporter is cleaved from the probe resulting in a fluorescent signal being detected. Once the primer extends enough to release the quencher this signal is blocked. By using probes with different fluorescent signals multiple PCR assays can be multiplexed and run together.

PCR reaction plot

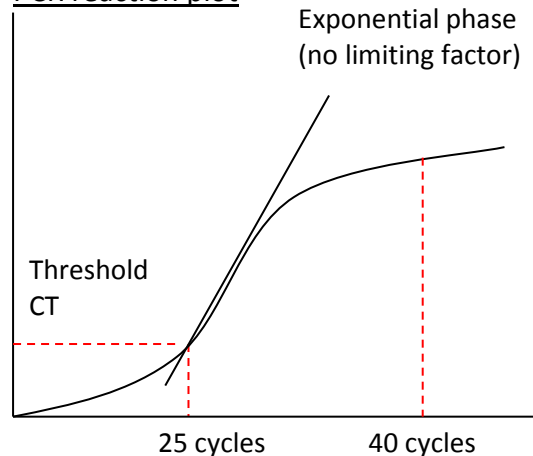

The number of cycles the PCR takes to reach a set threshold is known as the CT value. This is inversely correlated to the amount of template DNA in the sample.

e.g. CT 25 = 2 x template DNA

CT 26 = 1 x template DNA

CT above 30 = no template represented in the sample

CT value can be used to determine how many copies of a particular allele samples have.



qPCR Assay Types

All qPCR assays are FAM labelled and run in duplex with a VIC labelled internal control, Dot1l. There are 3 mutant qPCR assays based around the targeting cassette. They are as follows:

- : Neomycin assay Designed around the sequence of the neomycin resistance cassette.
- : LacZ assay Designed around the sequence of the LacZ reporter.
- : FRT-loxP Designed to detect the recombined sequence of the FRT and loxP area created when the Tm1a allele is Flp converted to the tm1c. The forward primer is based on the sequence of the 5' region upstream of the 5' FRT site which means this assay will only work for Tm1c/d.

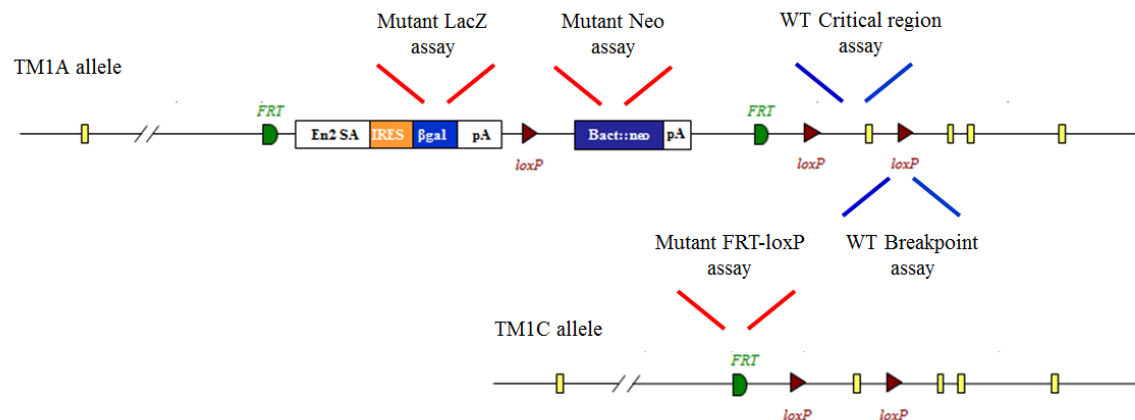

There are 2 WT qPCR assays based on WT sequence that may be lost in Tm1a/b/c/d alleles. They are as follows:

- : BP-LOA Break Point loss of allele assay. This is based on WT sequence that is lost around the loxP sites of the synthetic cassette.
- : CR-LOA Critical Region loss of allele assay. This is based on the critical region sequence that is flanked by the two loxP sites.



qPCR Mutant assay sequences

NEO assay (FAM labelled probe)

ATTGAACAAGATGGATTGCACGCAGGTTCTCCGGCCGCTTG GGTGGAGAGGCTATTCGGC TATGAC TGGGCACAACAGACAATCGGCTG CT CTGATGCCGCGGTGTTCCGGCTGTC
AGCGCAGGGGCGCCCGTTCTTTTTGTCAAGACCGACCTGTCCGGTGCCCTGAATGAACTGCAGGACGAGGCAGCGCGGCTATCGTGGCTGGCCACGACGGGCGTTCCCTTGCGCAG
CTGTGCTCGACGTTGTCACTGAAGCGGAAGGGACTGGCTGCTATTGGGCGAAGTGCCGGGCGAGGATCTCCTGTCATCTCACCTTGCTCCTGCCGAGAAAGTATCCATCATGGCT

Primer 1 = GGTGGAGAGGCTATTCGGC

Primer 2 = GAACACGGCGGCATCAG

Probe = TGGGCACAACAGACAATCGGCTG

LacZ assay (FAM labelled probe)

CGATAAAAAACAACCTGCTGACGCCGCTGCGCGATCAGTTCACCCGTGCACCGCTGGATAACGACATTGGCGTAAGTGAAGCGACCCGCATTGACCCTAACGCCTGGGTGAAACGCT
GGAAGGCGGCGGGCCATTACCAGGCCGAAGCAGCGTTGTTGCAGTGCACGGCAGATACACTTGCTGATGCGGTGCTGATTACGACCGCTCACGCGTGGCAGCATCAGGGGAAAACC
TTAT TTATCAGCCGGAAAACCTACC GGATTGATGGTAGTGGTCAAATGGCGA TTACC GTTGATGTTGAAGTGGCGAG CGATACACCGCATCCGGCGCGGATTGGCCTGAACTGCCA
GCTGGCGCAGGTAGCAGAGCGGGTAAACTGGCTCGGATTAGGGCCGCAAGAAAACATCCCGACCGCTTACTGCCGCCTGTTTTGACCGCTGGGATCTGCCATTGTCAGACATGT

Primer 1 = CTCGCCACTTCAACATCAAC

Primer 2 = TTATCAGCCGGAAAACCTACC

Probe = TCGCCATTTGACCACTACCATCAATCC

FRT-LOXP-mut2 assay (FAM labelled probe)

AAGGCGCATAACGATACCACGATATCAACAAGTTTGTACAAAAAGCAGGCTGGCGCCGGAACCGAAGTTCCCTAT TCCGAAGTTCCCTATTCTCTAGA AAGTATAGGAAC TTC<GTC
GAGATAACTT>CGTATAGCATACATTATACGAAG

Primer 1 = AGGCGCATAACGATACCACGATA

Primer 2 = TGCTATACGAAGTTATCTCGACGA

Probe = TCCGAAGTTCCCTATTCTCTAGA



qPCR WT assay sequences

Fam151b BP-LOA-wt1 assay (FAM labelled probe)

Blue = Sequence in homology arm Black = breakpoint Red = critical region

```
ATAAAGAGTCTTGCAGTTGCCCTGTTGGCACGGAAATTATATTTTTATTGTACTTTTTATTTGAAAGTTTGTCTTCTCCAAACTCGAAGG<TGAGGTCTCTAGGGAGGTTTGGGGGTC  
TAAATTGGAAACA>TTTCCTTAGTATGCTATTAAAAAAGTCCCAACAGCGAATTGTTACCTTTTCCTCGAACAATCCTTATCACAATTGACGCTTTGAGCATCTCCTCGAAACCACC  
TGTGTCAGCTCATAGTACTTACTAGGCAAGTAGCACCTTTGAGGGACACTCTGTGTCCAAATATACTATTTTTATTACCAACAAATGCTTAATAGACTTCCCTTCTTTCTGTGTT
```

Primer 1 = GTCTTGCAGTTGCCCTGTTG

Primer 2 = GTTTCGAGGAAAGGTGAACAATTCG

Probe = AACTCGAAGGTGAGGTCTCTAGGGA

Fam151b CR-LOA-wt1 assay (FAM labelled probe)

```
CCTTTGAGGGACACTCTGTGTCCAAATATACTATTTTTATTACCAACAAATGCTTAATAGACTTCCCTTCTTTCTGTGTTCACTTTGCTAGATGCTAGAAAAGATTTGTAGGCAG  
GATAATGGCTGAGGAGCTTTGGGATCTATGGATAGCATGCGGGCCTCGTACAGTGCCTGACATTCTAGAGTTGCTCGGTGTCTCTTCTTTCTCACATGGGCACCGAGGCGCTTCTC  
CTCGATTTTCTGCTCCTTGTTCACAGTAACGTAAGCTCTTACTTGGGTAGGTGCTGCCACATGATAGAGGCTGATGTCCTTCTTCTTAGTGACGGATCAGAGCATGGCCAGCCAA
```

Primer 1 = GCTGAGGAGCTTTGGGATCTATG

Primer 2 = GGTGCCCATGTGAGAAAGAAG

Probe = TAGCATGCGGGCCTCGTACAGT

All qPCR assays are run in duplex with a VIC labelled internal control, Dot1l

Dot1l internal control (VIC labelled internal control)

```
AACCAGTGGGCAGTGGATGTGAAGGGCAGGAAGCTCATAGGGTGACTGGCCAACCCAGGGAAGCCGGAGTGTGCGTCTTCTGTTTCTTTTCCCTCTAGTCGTTTTCT  
GTTAGTAGTTGGCATCCTTATGCTTCATCTTACAGTCGACTTGAGAGCTGCCCTGAATGGTCGTGCTGGGGCAAGGCTTTATTTTCAGGCGTAGCACACATGGTGGCCAATGGGAC  
TCTGTAGGATCTGCCACACCCATCAGGTGTGCAGGGAGACAGAGCTGAGTCAGGCTCCAGCTCTGGGGAATATGTTGAGTCACCACCTCTGTAGGGTGGTTGTGCATCATAGAAC
```

Primer 1 = GCCCCAGCACGACCATT

Primer 2 = TAGTTGGCATCCTTATGCTTCATC

Probe = CCAGCTCTCAAGTCG



qPCR genotyping set up

qPCR master mix

ABI GTX Taqman master mix	5 μ l
Primers Dot1L_2F (20 μ M)	0.225 μ l
Primers Dot1L_R (20 μ M)	0.225 μ l
Probe DotL_2M (5 μ M)	0.2 μ l
FAM Assay (probe 5 μ M & primers 15 μ M each)	0.3 μ l
Water	1.55 μ l

ALIQUOT 7.5 μ L

DNA 2.5 μ l
(1/10 dilution of ABI Sample-to-SNP prep)

The results to the right have been run on an ABI 7500 and analysed using the ABI software CopyCaller. Each sample was run with a technical duplicate and for each assay, Neo and the BP-LOA, 7 controls of known copy number and a no template control, all in duplicate were run so the software can accurately copy count.

Generic example of a NEO + BP-LOA copy called result

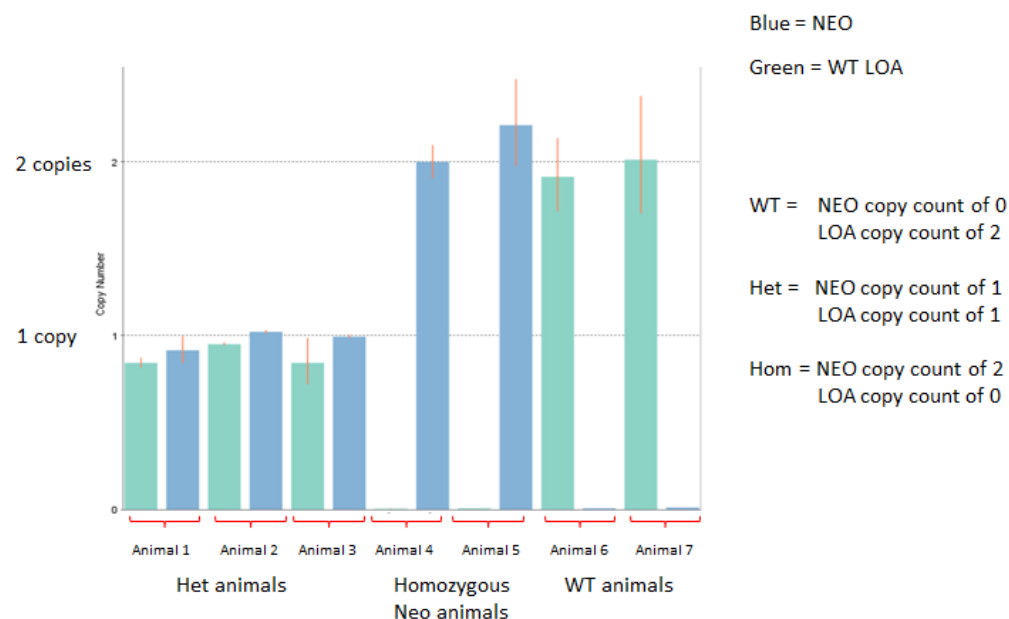



qPCR based genotyping strategy summary

	Assay to use and copy number expected per allele									
	NEO		LACZ		FRT-loxP		BP-LOA		CR-LOA	
WT	✓	0					✓	1		
Tm1a + PL-Tm1a	✓	1					✓	0		
Tm1b	✓	0	✓	1					✓	0
PL-Tm1b	✓	1	✓	1					✓	0
Tm1c			✓	0	✓	1	✓	0		
Tm1d			✓	0	✓	1	✓	0	✓	0

	Expected copy number per animal				
	NEO	LACZ	FRT-loxP	BP-LOA	CR-LOA
WT	0	0	0	2	2
Tm1a-HET	1	1	0	1	2
Tm1a-HOM	2	2	0	0	2
Tm1b-HET	0	1	0	1	1
Tm1b-HOM	0	2	0	0	0
PL-Tm1b-HET	1	1	0	1	1
PL-Tm1b-HOM	2	2	0	0	0
Tm1c-HET	0	0	1	1	2
Tm1c-HOM	0	0	2	0	2
Tm1d-HET	0	0	1	1	1
Tm1d-HOM	0	0	2	0	0

Assays that are normally run to detect allele

Assays not normally run

Please note copy numbers are based on what is expected for autosomal genes



Allele Conversions

The action of either Flp or Cre recombinase can be used to convert the KO 1st alleles described in this document. Both gel based and qPCR genotyping methods may be employed to detect animals carrying the DNA sequences coding for these proteins.

Cre Genotyping

Cre gel based assays are run using primers specific to DNA sequences encoding Cre recombinase as well as a set of primers detecting a house keeping gene Slc40a1. These are run using the same cycling conditions as described in page 4.

ActinB-Cre gel based primers

Cre_F1	GCGGTCTGGCAGTAAAACTATC
Cre_R1	GTGAAACAGCATTGCTGCTCACTT
Slc40a1_sh_F (control)	CCTTTGTAACCTCCTCTGTGTC
Slc40a1_sh_R (control)	CTGAAGTCTTTCATGATAACTGCATT

Fragment sequences

Slc40a1 147bp

CCTTTGTAACCTCCTCTGTGTCTTTATTTTAGCCTAAACAGCAAAGACTTAAAAGATGGATCTTATCTGGAGAATAGTTCTATTTAGTCCAGCAAACCTTCTAGTAAATATGTTAG
ATGAAA**AATGCAGTTATCATGAAAGACTTCAG**

Cre1 102bp

GCGGTCTGGCAGTAAAACTATCCAGCAACATTTGGGCCAGCTAAACATGCTTCATCGTCGGTCCGGGCTGCCACGACCA**AGTGACAGCAATGCTGTTTCAC**



Allele Conversions

Cre Genotyping

Cre qPCR assay (FAM labelled probe)

ATGTCCAATTTACTGACCGTACACCAAATTTGCCTGCATTACCGGTCGATGCAACGAGTGATGAGGTT **CGCAAGAACCTGATGGACATG** **TTCAGGGATCGCCAGGCGTTT** TCTGAGCATACTGGAAAATGC **TTCGTCCGTTTGCCGGT** CGTGGCGGGCATGGTGCAAGTTGAATAACCGGAAATGGTTTCCCGCAGAACCTGAAGATGTTTCGCGATTATCTTCTATATCTTCAGGCGCGCGGTCTGGCAGTAAAACTATCCAGCAACATTTGGGCCAGCTAAACATGCTTCATCGTTCGGTCCGGGTGCCACGACCAAGTGACAGCAATGCTGTTTCACTGGTT

Primer 1 = **CGCAAGAACCTGATGGACATG**

Primer 2 = **ACCGCAAACGGACAGAA**

Probe = **TTCAGGGATCGCCAGGCGTTT**

qPCR set up for the Cre assay is exactly the same as previously, where the assay is run in duplex with a VIC labelled Dot1l internal control.



Allele Conversions

Flpe Genotyping

Flpe gel based assays are run using primers specific to DNA sequences encoding Flpe recombinase as well as a set of primers detecting a house keeping gene Slc40a1. These are run using the same cycling conditions as described in page 4.

Flpe gel based primers

ICS_Flpe_F	TCTTTAGCGCAAGGGGTAGGATCG
ICS_Flpe_R	GTCCTGGCCACGGCAGAAGC
Slc40a1_sh_F (control)	CCTTTGTAATTCCTCTGTGTC
Slc40a1_sh_R (control)	CTGAAGTCTTTCATGATAACTGCATT

Fragment sequences

Slc40a1 147bp

CCTTTGTAATTCCTCTGTGTCTTTATTTTGTAGCCTAAACAGCAAAGACTTAAAAGATGGATCTTATCTGGAGAAtagttctatttagtcCAGCAAACCTTCTAGTAAATATGTTAG
ATGAAAATGCAGTTATCATGAAAGACTTCAG

ICS-Flpe1 332bp

TCTTTCTTTAGCGCAAGGGGTAGGATCGATCCACTTGTATATTTGGATGAATTTTGTAGGAATTCTGAACCAGTCCTAAAACGAGTAAATAGGACCGGCAATTCTTCAAGCAACAA
ACAGGAATACCAATTATTTAAAAGATAACTTAGTCAGATCGTACAACAAGGCCTTGAAGAAAAATGCGCCTTATCCAATCTTTGCTATAAAGAATGGCCAAAATCTCACATTGGAA
GACATTTGATGACCTCATTCTGTCAATGAAGGGCTAACGGAGTTGACTAATGTTGTGGAAATTTGGAGCGATAAGCGT**GCTTCTGCCGTGGCCAGGAC**



Allele Conversions

Flpe Genotyping

Flpe qPCR assay (FAM labelled probe)

GGTAGGATCGATCCACTTGTATATTTGGATGAATTTTTGAGGAATTCGAACCAGTCCAAAACGAGTAAATAGGACCGGCAATTCCTCAAGCAACAAACAGGAATACCAATTATT
AAAAGATAACTTAGTCAGATCGTACAACAAGGCTTTGAAGAAAAATGCGCCTTATCCAATCTTGTATAAAGAATGGCCAAAATCTCACATTGGAAGACATTTGATGACCTCAT
TTCTGTCAATGAAGGGCCTAACGGAGTTGACTAATGTTGTGGGAAATTGGAGCGATAAGCGTGCTTCTGCCGTGGCCAGGACAACGTATACTCATCAGATAACAGCAATACCTGAT
CACTACTTCGCACTAGTTTCTCGGTACTATGCATATGATCCAATATCAAAGGAAATGATAGCATTGAAGGATGAGACTAATCCAATTGAGGAGTGGCAGCATATAGAACAGCTAAA
GGGTAGTGCTGAAGGAAGCATACGATACCCCGCATGGAATGGGATAATATCACAGGAGGTACTAGACTACCTTTCATCCTACATAAATAGACGCATATAAT

Primer 1 = GTGGGAAATTGGAGCGATAAGC

Primer 2 = ACCGAGAACTAGTGCGAAGTAG

Probe = CTTCTGCCGTGGCCAGGACAAC

qPCR set up for the Flpe assay is exactly the same as previously, where the assay is run in duplex with a VIC labelled Dot1l internal control.