

Funktion-One Research LTD
 Hoyle, Beare Green, Dorking, Surrey, RH5 4PS, UK
 mail@funktion-one.com +44 (0)1306 712820

Sheet: Dimensions
 Funktion-One Product Technical Drawing

A3 Sheet Scale: 1:5

Drawn By: Mike Igglesden 13/12/2021

Filename:

F101.2-F1-TD=T0045-00

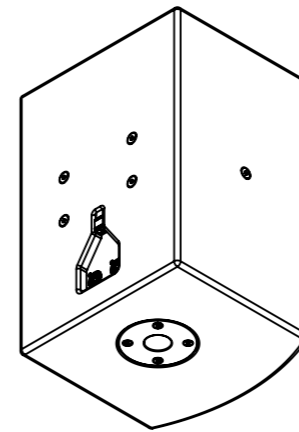
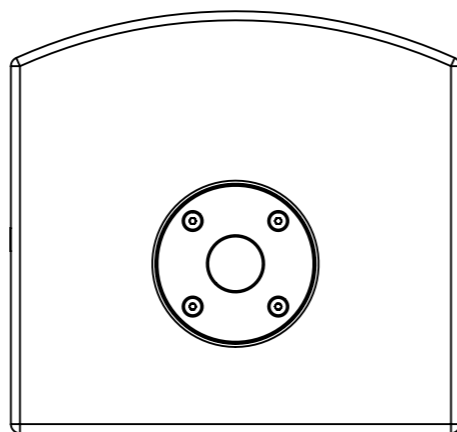
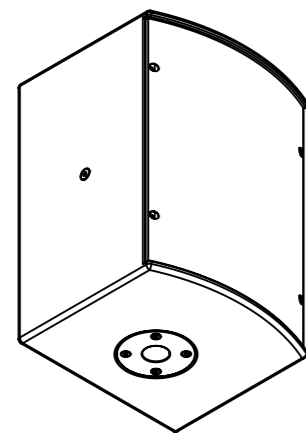
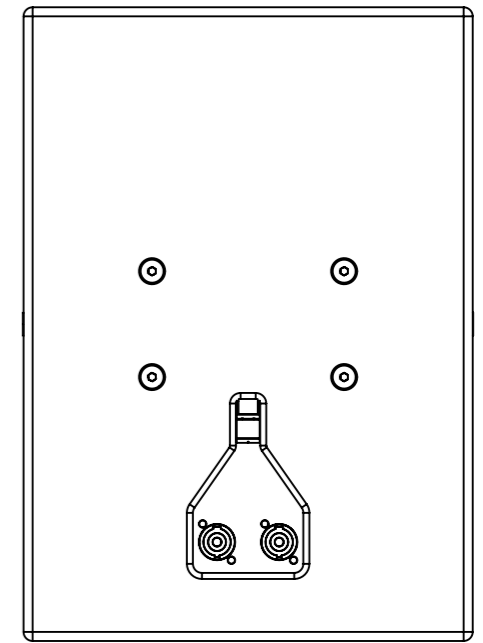
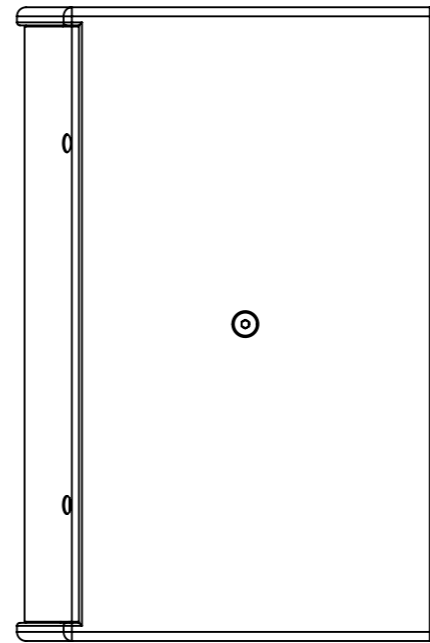
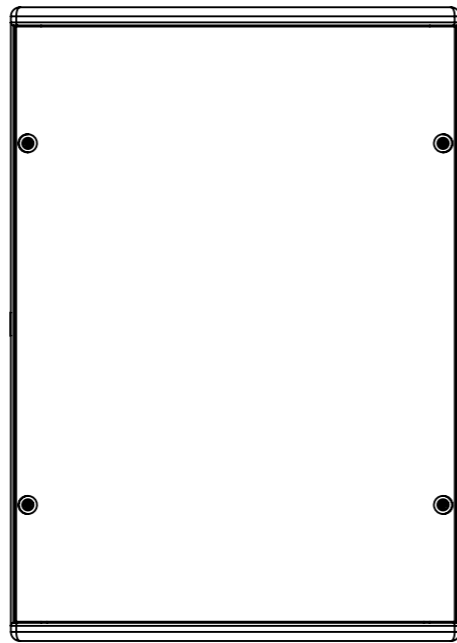
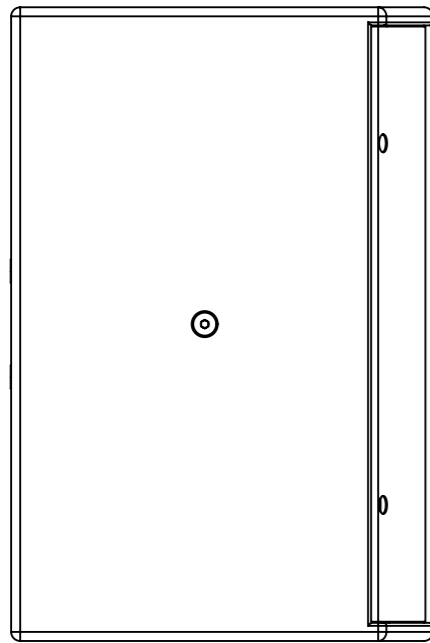
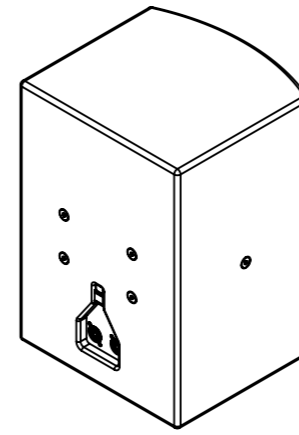
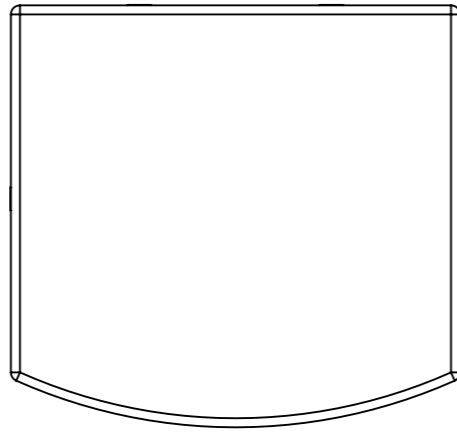
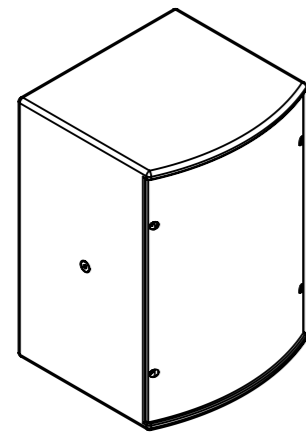

Funktion-One Research LTD
 Hoyle, Beare Green, Dorking, Surrey, RH5 4PS, UK
 mail@funktion-one.com +44 (0)1306 712820

Sheet: Standard

Funktion-One Product Technical Drawing

A3 Sheet Scale: 1:5

Filename:

Drawn By: Mike Igglesden

13/12/2021

F101.2-F1-TD=T0045-00

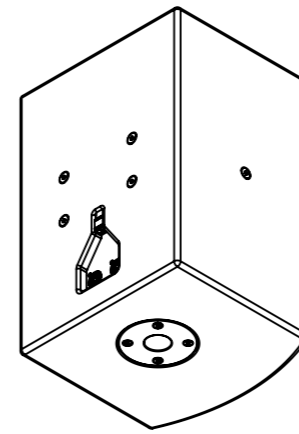
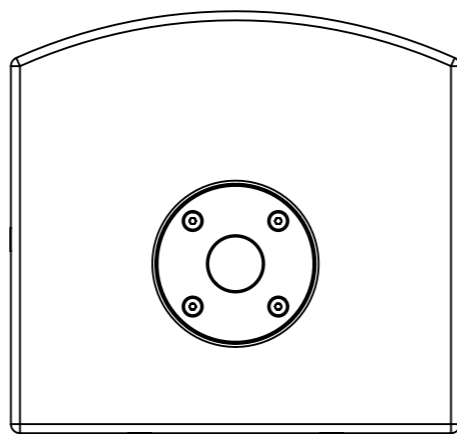
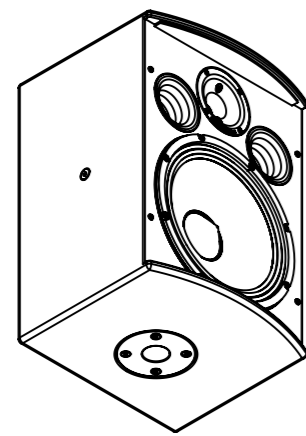
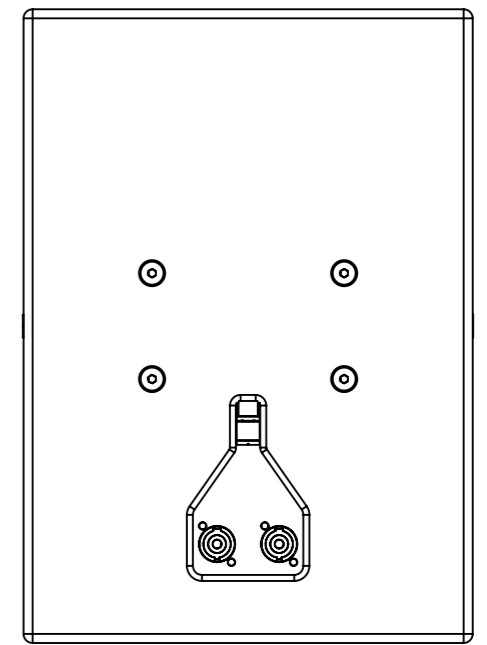
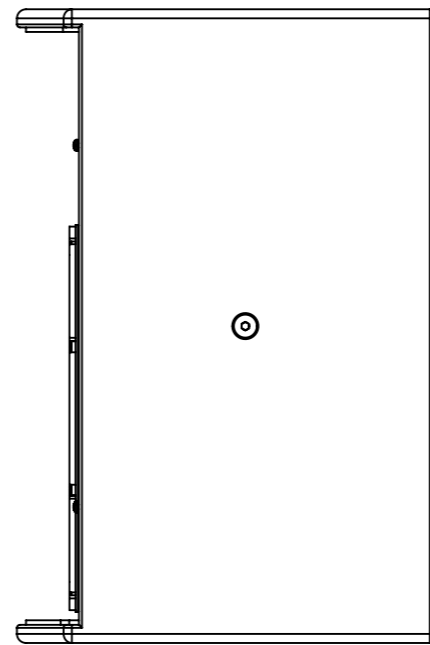
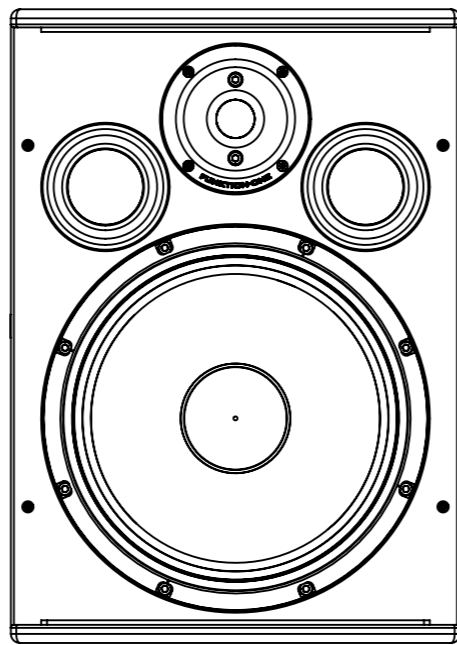
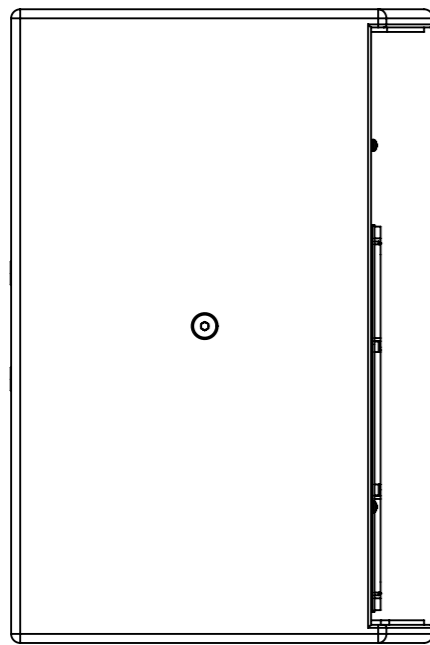
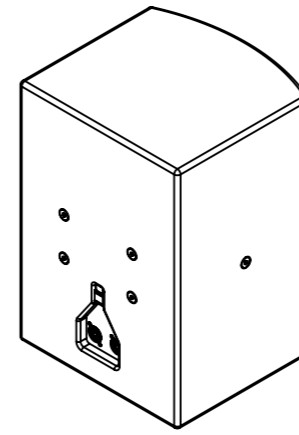
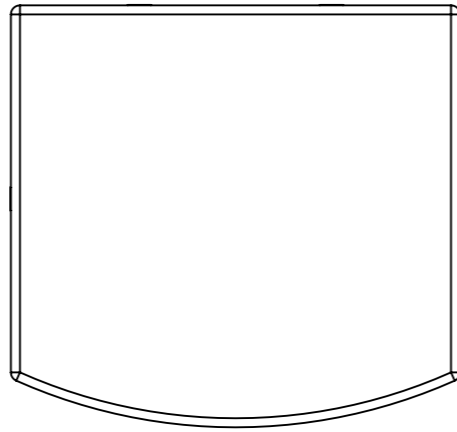
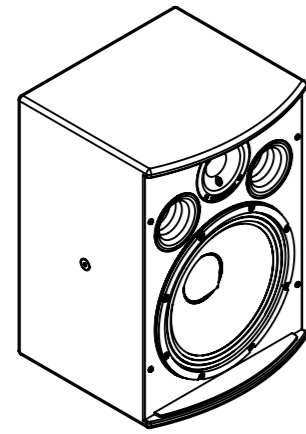

Funktion-One Research LTD
 Hoyle, Beare Green, Dorking, Surrey, RH5 4PS, UK
 mail@funktion-one.com +44 (0)1306 712820

Sheet: No Grille

Funktion-One Product Technical Drawing

A3 Sheet Scale: 1:5

Filename:

Drawn By: Mike Igglesden

13/12/2021

F101.2-F1-TD=T0045-00